

RUSSIAN ACADEMY OF SCIENCE
Lenin Order of Siberian Branch
G.I. Budker INSTITUTE OF NUCLEAR PHYSICS

A.Batnikov, I.Ilyin, V.Kozak, E.Kuper,
V.Mamkin, V.Ovchar, G.Fatkin,
V.Tsukanov, P.Vobly, A.Volkov, S.Zverev

THE NEW VME-BASED SYSTEM
FOR MAGNETIC MEASUREMENTS
WITH HALL SENSORS

Budker INP 2007-32

Novosibirsk
2007

The New VME-based system for magnetic measurements with Hall sensors

*A. Batrakov, I. Ilyin, V. Kozak, E. Kuper, V. Mamkin, V. Ovchar,
G. Fatkin, V. Tsukanov, P. Vobly, A. Volkov, S. Zverev*

Budker Institute of Nuclear Physics
630090, Novosibirsk, Russia

Abstract

The systems with Hall sensors are widely used for magnetic measurements. In BINP for creation of measuring systems with Hall sensors CAMAC - electronics were used for many years. The paper describes the new VME-based system and MS Windows application developed for replacement of old system. The features of specialized VME-units and new software capabilities are reported. The examples of applications and practice results are presented also.

Новая VME-система для магнитных измерений с помощью датчиков Холла

*А. Батраков, И. Ильин, В. Козак, Э. Купер, В. Мамкин, В. Овчар,
Г. Фаткин, В. Цуканов, П. Воблый, А. Волков, С. Зверев*

Институт ядерной физики им. Г.И. Будкера
630090, Новосибирск, Россия

Аннотация

Системы использующие датчики Холла широко применяются для проведения магнитных измерений. В ИЯФ СО РАН много лет эксплуатировалась система магнитных измерений с помощью датчиков Холла, использующая аппаратуру САМАС. В данной работе описывается новая, базирующаяся на аппаратуре в стандарте VME и Windows-ориентированном программном обеспечении, система магнитных измерений, созданная для замены старой системы. Приводятся описания специализированных VME-модулей и новых возможностей программного обеспечения. В работе представлены примеры практического применения новой системы.

© Budker Institute of Nuclear Physics, SB RAS

1. Introduction

In BINP for creation of measuring systems with Hall sensors CAMAC - electronics were used for many years [1]. These systems had good parameters and successfully used for measurements of magnets produced in BINP as for installations of VEPP-family as for out-of-BINP facilities: Siberia-1,2 (KSRS, Russia), LHC (CERN), SLS (Switzerland), BESSY (Germany), SAGA (Japan) [2,3]. Hardware deterioration and MS DOS application of previous system demanded to design a new electronics and modern software.

The Hall measuring system can be assembled on the base of multi-purpose instrumentation, like precision voltmeters, analogue multiplexers, current sources etc. Example of such system may be found in [5]. Unfortunately, the similar way of building of Hall measuring system appears redundant and expensive enough, although not always meets all requirements to such systems. Besides, the manufacturing rate of a plenty of the various magnets produced in BINP, demands several measuring systems.

Note also, that for controlling the peripheral equipment like power supplies or stepping motors, the system should contain corresponding interface devices. So, the modular system, including a specialized and interface modules looks quite suitable to solve problem. In 2004 when we have begun this work, we already had BINP-made VME-controller, prototype of precision ADC and step motor controller, equipped with RS-232 interface. That fact has defined a choice of modular system and its configuration.

Thus, we decided to design specialized, easy-to-replicated, BINP-made, VME-based Hall measuring system.

2. Electronics of Hall-sensor measuring system

2.1. Basics

The Figure 1 demonstrates the structure of measuring system. The last one consists of a few modules, installed at VME-crate: crate-controller BIVME-1, VME \leftrightarrow RS-232 interface, VME \leftrightarrow CAN interface and three specialized units: Hall Sensor analogue Interface (VMEHSI), precision ADC (VMEADC16) and Hall Sensor Thermo Stabilizer (VMEHTS). All modules, except RS-232 interface, are fabricated in Budker INP. The total space required for electronic modules is 7 units in standard 6U crate. During calibrating procedures the set of specialized NMR units may be installed in crate [4]. For this case the total space is 11 units.

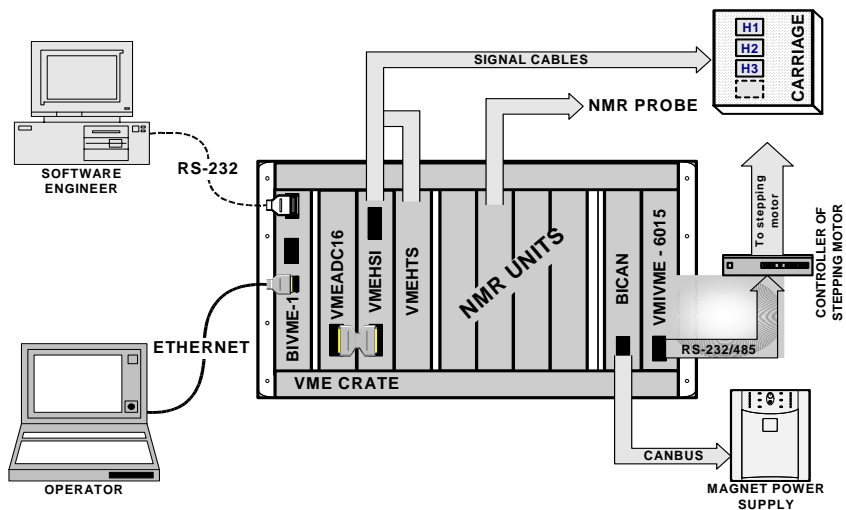

Figure 1. The structure of Hall measuring system.

External devices include carriage with sensors, step motor controller, located close to step motor at carriage moving assembly and magnet power supply. RS-232 interface controls step motor controller via serial link.

Magnet power supply is controlled via CAN-bus with the help of VME \leftrightarrow CAN interface unit. As option outputs of RS-232 unit may be enabling for control of magnet power supply, if last one equipped with RS-232 interface.

Hall Sensor analogue Interface VMEHSI is intended for supplying of Hall sensors and for the interfacing of the sensors chain and ADC. Precision ADC VMEADC16 converts output voltages of VMEHSI to 23-bit digital data.

Module VMEHTS performs temperature stabilization of holder with Hall sensors.

BIVME-1 carries out CPU and VME-master functions. Presence of built-in Ethernet-interface allows to integrate easily Hall system into structure of a modern computer complex.

Essential details and specifications of CPU and other electronic modules are presented below.

2.2. Crate controller BIVME-1

BIVME-1 is standard VME controller with onboard flash disk. The operating system used is uClinux (Linux for microcontrollers). The main advantage of this Linux release is small memory consumption. Kernel and all necessary utilities are

entirely located on the flash disk. On this reason the system is started and initialized independently of operators PC. For interfacing with other hardware modules, several loadable Linux drivers are developed. Short-form specifications of BIVME-1 listed in Table 1.

Table 1 Specifications of BIVME-1.

CPU	Motorola MC68EN360
Clock	32 MHz
RAM	32-bit, 8 /16 Mbytes
ROM	128 Kbytes Boot ROM
Flash memory	8 Mbytes
I/O ports	2: RS-232, 1: Ethernet 10base-T
Other	Real time clock; 2 Kbytes non-volatile memory

2.3. Carriage and its thermostabilization

The fact, that Hall-sensors are temperature-dependent elements is well known. A few methods are available in order to reach good thermostability of Hall measuring system: pre-selection of sensors, stabilization of sensor temperature, correction of measuring data in accordance with sensor temperature.

Correction of measuring data is good method for one-two sensor assembly (as in magnetometers). Usually for magnet measurements multi-sensor assembly looks more preferable. In old BINP system the carriages, containing from 7 up to 25 sensors are normally used. As a result preparation of correction table for each sensor is hard task. For this reason we decided to stabilize sensor temperature. Special Hall-sensors holder, equipped with heater and thermo probe is developed in order to realize temperature stabilization. The holder is a copper bar on which Hall sensors are mounted (see Figure 2). Holder is fixed on a carriage. Two twisted copper wires of the same length are bifilarly coiled at special slots made on holder. One of the wires is used for heating; the other one is intended for measuring holder temperature. The holder is heated up to 40°C and its temperature is stabilized with the help of linear analogue regulator. Thin fiberglass pad is placed between holder and copper carriage to arrange small heat consumption.

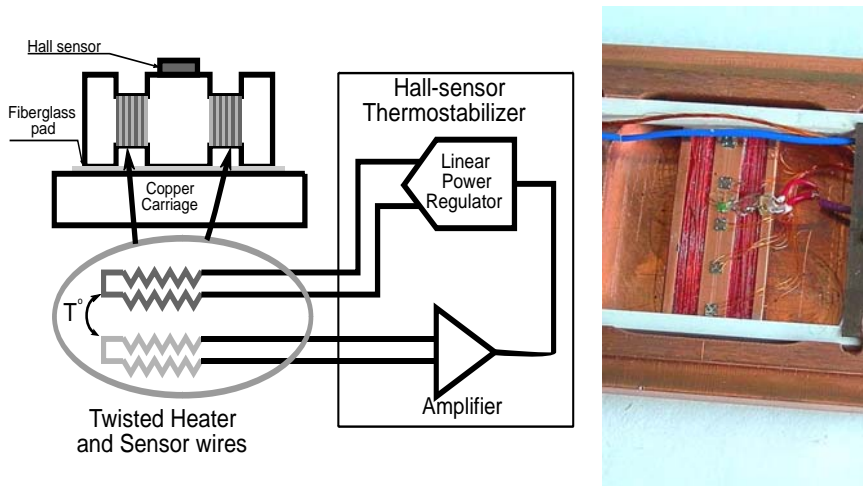

Figure 2. Principles of sensors thermostabilization and view of sensors, installed on thermostabilized holder

VME Hall Thermostabilizer (VMEHTS) module has two channels so it can stabilize temperature of two holders simultaneously. Thermostabilizer maintains holder temperature with accuracy $\pm 1^{\circ}\text{C}$, maximum total power at holder – 3.6W, thermal resistance to carriage $\sim 5^{\circ}\text{C/W}$.

2.4. The Hall-sensor analogue interface VMEHSI

VME Hall Sensor Interface designed as specialized analog module destined for Hall measuring systems. That circumstance has influenced as for scheme solution as for chosen of electronic components.

The simplified structure of VMEHSI presented at right side in Figure 3. The main parts of this unit are: 32-channel 3-wire analogue multiplexer, sensor supplying current source and built-in precision output amplifier.

This unit determines accuracy of whole system. Typical Hall-sensor sensitivity is $5 - 20 \mu\text{V/Gs}$, so in order to achieve desired error in magnetic field measurement about $\pm 0.1\text{Gs}$ we need to obtain an error at electronic equipment less than $\pm 1\mu\text{V}$. This value is quite small and first of all we should consider a thermoelectric effects. Commonly used semiconductor chips have covar pins; and problem in that thermocouple voltage of kovar-copper is very large - $40 \mu\text{V/C}^{\circ}$. As a result we used multiplexer and amplifier chips with copper pins.

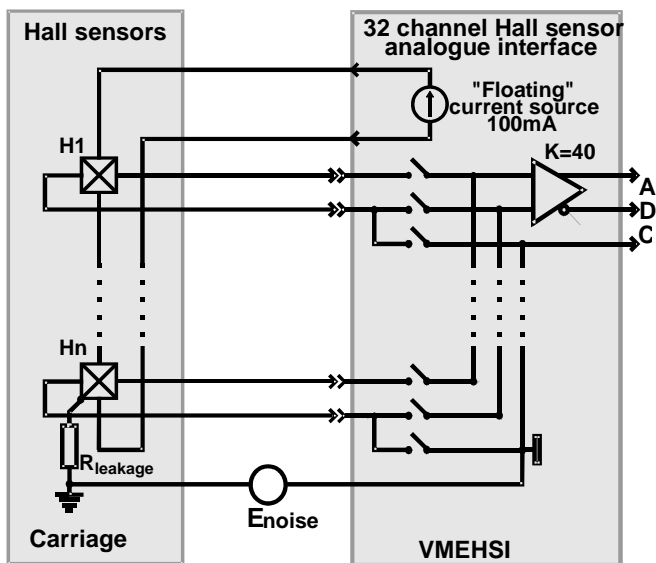

Figure 3. The structure of VMEHSI and its connections to Hall sensor carriage

At a following stage of researches it was revealed, that printed board, containing semiconductor chips with copper pins needs in thermal-smoothing pad, because of heated parts not far from precision elements. These parts generate temperature gradients, which results in thermoelectric voltage. Note, that even clean Cu-Cu junction has thermoelectric potentials about $0.2\mu\text{V}/\text{C}^\circ$ and Cu-Sn potential is $2\mu\text{V}/\text{C}^\circ$ [6]. After installation of aluminum thermo – smoothing pad offset drift caused by self-heating decreased from $3\mu\text{V}$ up to $1\mu\text{V}$.

Next discussion concerns common mode voltage rejection. Voltage drops on a chain of serially connected Hall sensors amounts to 12V. It means that preamplifier or measuring devices should be able to reject common mode voltage more than $2 \cdot 10^7$ times. This demand is very hard. One of ways to solve this task - using isolated from ground (“floating”) sensor’s circuit and ground the measuring part. With the same success you can ground one node point at sensor’s circuit and make “floating” measuring device. The decision to make isolated sensor’s chain looks simpler, because to realize it we need only to do “floating” current source 100mA.

In order the measuring circuit works correctly it is necessary to ground during sequential multiplexing one signal terminal of each sensor, i.e. arrange, in other words, “dynamic grounding”. The described method requires two simultaneous working switches: first – for “high” sensor’s terminal, second – for “low” or

grounded terminal. This decision is well known, commonly used, but doesn't consider E_{noise} - a voltage between grounds of "physical iron" and electronic equipment. In reality this difference of potentials amounts to a few Volts. If take into account the presence of leakage resistance $R_{\text{leakage}} \sim 0.3\text{G}\Omega$ between sensor's chip and holder, than that fact results in error more than $1\mu\text{V}$, because of switch resistance ($\sim 300\Omega$). We proposed three - switches scheme (see Fig.3) to eliminate $R_{\text{leakage}} + E_{\text{noise}}$.

The final point of VMEHSI design is built-in output amplifier with gain 40. This amplifier serves for matching of low-level sensor's voltage and input range of ADC. Amplifier's differential output requires differential input from ADC, but it is not limiting requirements because a precision ADC usually has differential input.

In standard interconnection of Hall system the first six channels of VMEHSI intended for measure of technological signals. They are: short circuit, Hall supplying current, holder temperature and voltage on sensor's chain. The total amount of Hall probes, which may be used in system, is 26.

The main specifications of VMEHSI are listed below in Table 2.

Table 2. VMEHSI specifications

Number of input channels	32 differential
Input voltage range	$\pm 250\text{ mV}$
Max common mode voltage	$\pm 12\text{ V}$
Output amplifier gain	$40.000 \div 40.002$
Gain error	$\pm 10\text{ppm}$
Gain drift	$\pm 1\text{ppm}/\text{C}^\circ$
Peak-peak input noise	$2\mu\text{V}$
Offset drift	$\pm 30\text{nV}/\text{C}^\circ$
Hall sensors supplying current	$99.996 \pm 0.001\text{mA}$
Current drift	$\pm 2\text{ppm}/\text{C}^\circ$
Max voltage at current terminals	12V
Shunt resistance	$2.503325\Omega \pm 5\mu\Omega$
Shunt resistance drift	$\pm 1.5\text{ppm}/\text{C}$
Size	2M

2.5. Precision ADC

VMEADC16 consists of delta-sigma ADC-chip with differential inputs, 16-differential channel analogue multiplexer, reference source, calibration reference source and embedded microcontroller [9]. An analogue part of device is galvanically isolated.

Delta-sigma converter provides very high resolution with low noise level, but they have low stability. There is used a calibration procedure in order to compensate this instability. An on-board micro-controller performs the calibration procedure in hidden-of-user way. Else microcontroller manages all of device operations.

The specifications of VMEADC16 are listed below in Table 3.

Table 3. VMEADC16 specifications

Resolution	23bits
Input voltage range	$\pm 10V$
Number of channels	16
Accuracy @ $20^{\circ} \div 50^{\circ}$	0.003%
Offset	$\pm 20\mu V$
Peak-to peak noise @ 20ms	$40\mu V$
Common mode DC-voltage rejection	-100 dB
Effective number of bits @ 20ms	20 bits
Time interval between samples	5,10,20,40,80,160 ms
Min. Time per measure for Hall system	80 ms
Size	1M

3. Software

The software of the new magnetic measurement system is a complex of functional specific programs. The architecture of the software is based on client-server model (Figure 4).

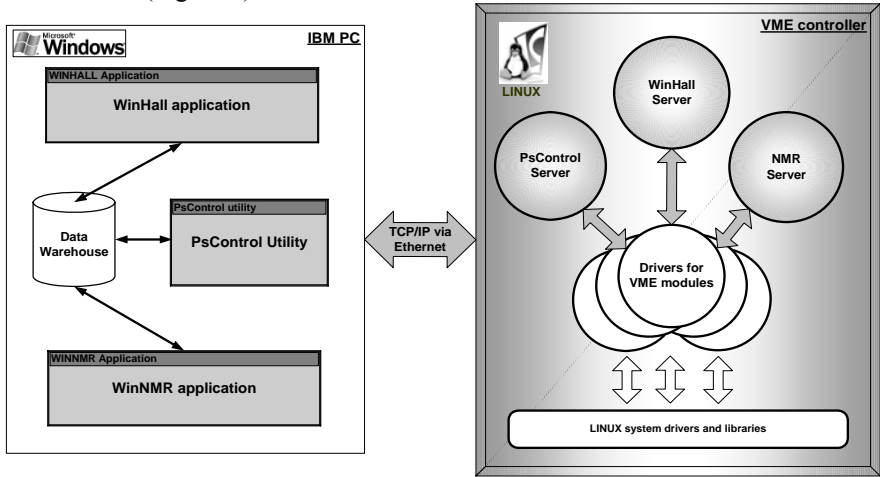

Figure 4. Architecture of software of Hall measuring system

The embedded low-level (hardware specific) software operates on VME-controller under the μ Linux operational system (<http://www.uclinux.org>). There are drivers and low-level libraries for all VME-modules like as VMEHSI, VMEADC16, interfacing units (CAN, RS-232/485) and NMR-based magnetometer units. The classical TCP/IP server is started at the VME-controller. The server is responsible for interfacing with clients (high-level task specific software). The embedded software is located on the flash disk as firmware of the system controller and starts-up immediately after power on.

There are the next client's programs executed in operator's computer under Microsoft Windows 2000/XP operational system:

- **WinHall.** The tasks of main program WinHall are read out of Hall-probes and technological channels signals and processing of these data.
- **PSCANControl.** The task of PSCANControl utility is a control of magnet power supplies.
- **WinNMR** This is the special software for calibration of Hall-probes with the help of NMR-based magnetometer.

The WinHall program is a WIN32 application with user-friendly graphical interface. This program creates the connections to the TCP/IP-servers in the VME system controller and uses it to control the measuring system hardware. The main functions of the WinHall program are:

- Design of experiments. In the beginning of measurements operator setups the list of magnetic elements and list of measurements for each element. Some auxiliary information for each measurement is assigned (date and time, operator's name, text's comments).
- Planning the moving scenario of carriage for each measurement.
- Setting configuration of the hardware.
- Choice existent or creation the new configuration of Hall-carriage. The configuration of the carriage includes numbering of the Hall-probes, setting up the sequences of the Hall-probes measuring, description of the Hall-probe's positions on the carriage and choosing the calibration file for each Hall-probe.
- Measure or choose existent offsets of the Hall-probes. The offsets of the Hall-probes are considering during the measurements.
- Data storing with the help of data warehouse facilities. In current WinHall version the data warehouse based on ACSII-text files.
- "On-the-fly" visualization measured magnetic field. During measurement the program's GUI provides the real time dynamic plots for all processing data. The technological information (e.g. temperature of the holder, sensor supplying current, system offsets) is always accessible for operator at additional panel. All plots are easy to scalable, colorable and printable. Standard hotkeys and mouse-specific control are used.
- Calculation of the magnetic field using corresponding calibration files for Hall-probes. The values of the first and second integral (trajectory) are calculating and plotting in the real-time. The features of cross-sections visualization of the magnetic field and first integrals at the selected position are very popular.
- Taking into account the influence of perpendicular magnetic field for each Hall-probe. The correction is calculated using "orthogonal" calibration files.
- "Off-line" visualization and processing of stored data.

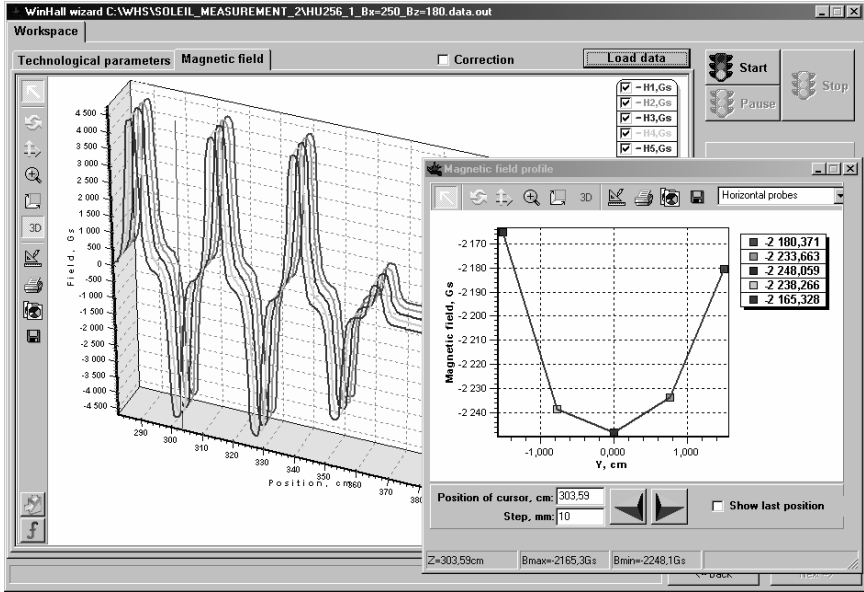

Figure 5. View of operator's main window of WinHall program and demonstration of visualization of measured data

The CAN bus as low-level interface of magnet power supplies is used in the BINP. The PSCANControl utility is developed for control and monitoring the power supplies. The program creates the connection with special TCP/IP-server at the VME-controller and uses it to communicate with the power supplies. There are the functions of PSCANControl:

- Initializing the CAN bus units and connection to the power supply.
- Configuring of the internal ADC and DAC of the power supply.
- Setting and reading actual output current.
- Monitoring of the interlocks of the power supply.
- Visualizing the state of the power supply on the long-time dynamic plots.

An accuracy calibration of the Hall-probes is a crucial factor for good results of the magnetic measurement. For calibrations purpose the special program WinNMR was developed. This program is WIN32 application under Windows 2000/XP operational system. To make a calibration file for carriage with the Hall-probes) the program performs:

- Connecting to the TCP/IP servers at the VME-controller and initializing the NMR-magnetometer modules, power supplies and Hall-probe's measuring electronics.
- Creating and editing carriage and system structure. Operator describes the Hall-probes, its positions on the carriage, channels of VMEHSI, directions of normal components of the magnetic field for Hall-probes. Also the operator's name, date and time of creation are stored.
- Measurement in the magnetic shield and storage the Hall-probe's offsets.
- Scheduling the process of calibration. The list of magnetic field values for calibration and sequences of points are prepared.
- Start the calibration process and monitoring the technological parameters during calibration.
- Inspecting the results of calibration. Draw the calibration curves and calculate the trends.
- Storage the calibration tables to use they in WinHall program. The ASCII text file format for calibration file is used.

4. Examples of applications

In 2005-2006 years four Hall-systems are manufactured in Budker INP and used for measure of different physical devices. The most interesting works were magnetic measurements of undulator HU256 and Permanent Magnet Wiggler [7,8].

Three elliptical undulators HU256 of electromagnetic type were produced, tested and magnetically measured by BINP for Synchrotron SOLEIL (France). The undulator has 12 main and 2 correction periods. The vertical magnetic field ($B_{max}=0.44$ T) is formed by 27 B_z magnet dipoles, and the horizontal magnetic field ($B_{max}=0.33$ T) is formed by 28 B_x dipoles.

Magnetic measurements of the undulators were provided by 2 methods, Hall probes and stretched wire. For HU256 measurements two identical Hall probe systems were manufactured: one used for magnetic measurement at the Budker INP, and another works at Synchrotron SOLEIL. View of undulator and measuring assembly are shown in Figure 6.

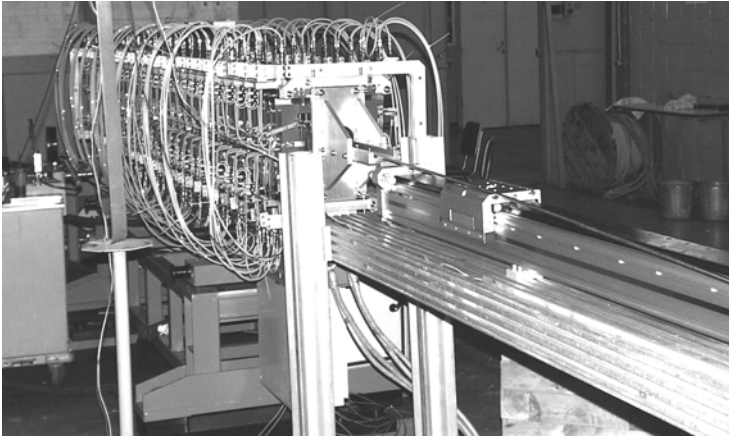

Figure 6. View of undulator and measuring assembly

The carriage contains two sets of probes located at two thermostabilized holders: first set - to measure vertical field, second one – for horizontal field. To measure field map the carriage moves along the undulator axis within the aperture with step 4mm. Field map for vertical and horizontal field shown in Figure 7. The accuracy of the magnetic field measurement by the Hall probe system is $\pm 20 \mu\text{T}$.

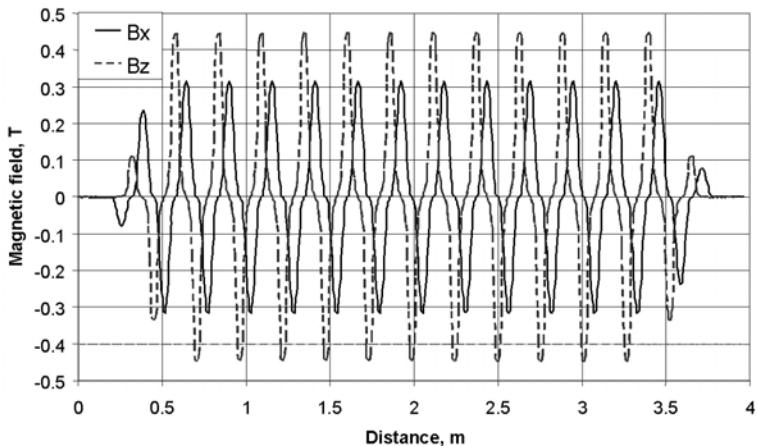

Figure 7. HU256 magnetic field map

Usually, the measurement and calculating magnetic field 1-st integral with the help of Hall probes is complicated but good test for system accuracy. To calculate 1-st integral the samples of field along undulator must be multiplied by step size and summarized. Obviously, the measuring errors due to offset or nonlinearity will be summarized also and reach to big total error.

The manufactured and assembled undulators were magnetically measured at BINP before transportation to SOLEIL. Then the undulators were re-measured after delivery. At SOLEIL site the stretched wire system is applied in additional for Hall measurements to get the 1-st integral parameters with improved accuracy $\pm 10 \mu\text{T}\cdot\text{m}$. The results of the magnetic measurements of one of undulators are shown in Figure 8. These results demonstrate accuracy about $\pm 50 \mu\text{T}\cdot\text{m}$ for the 1st integral.

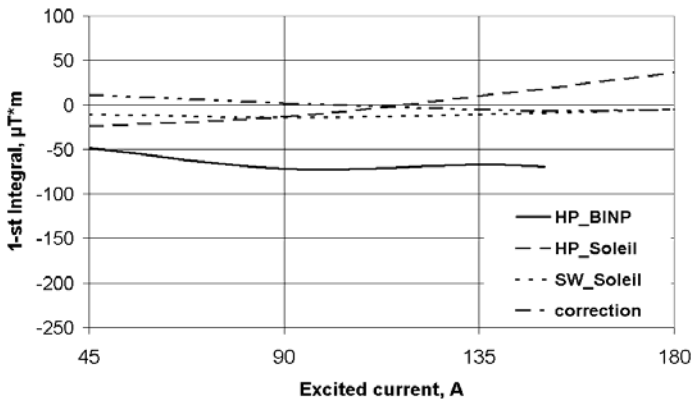

Figure 8. HU256 first integral vs. current

5. Conclusions

VME-based system for magnetic measurements with Hall sensors is developed. This system is completed specialized device, containing in one VME crate all hardware units, necessary to arrange Hall measurement. Software, prepared for system, allows capturing and storing data, processes it and visualizes results. Besides, this software has convenient graphical interface. By present time four VME Hall measuring systems are made at BINP. Systems are electrically tested at laboratory and after that used at measurement of real magnets.

Electronics demonstrates accuracy better than $\pm 10^{-5}$. Accuracy for magnetic field measurement depends of sensors and its calibrations. In best case we have **absolute accuracy better than $\pm 20 \mu\text{T}$ for field range $\pm 0.5\text{T}$** , typical value is $\pm 70 \mu\text{T}$ for fields up to 2T.

Acknowledgements

We would like express our thanks to Yu.Pupkov for his help and providing with information, I.Churkin, A.Steshov, N.Havin, A.Utkin for fruitful collaboration at carrying out of magnetic measurements of HU-256 undulator and Permanent Magnet Wiggler for PETRA-III. We wish to thank especially V.Shadrin, whose skilful hands made a few Hall-sensor carriages we used for measurements.

References:

- [1] *Yu.Golubenko, E.Kuper, A.Ledenev and A.Smirnov*, Apparatus for multichannel measurements of DC-voltages, *Avtometriya*, **No4**, 1986, p.64, Allerton Press, Inc.
- [2] *A.Batrakov, I.Churkin, O.Kiselev, et al.*, Bending magnets for the SAGA Storage Ring, *NIM A* **543** (2005), p.47, Elsevier B.V.
- [3] *K.M.Schrim, W.Kalbreier, V.Anashin et al.*, The Bending Magnets for the Proton Transfer Line of CNGS, *IEEE Transactions on Applied Superconductivity*, **Vol.16**, Issue 2, June 2006, p.1869.
- [4] *G.V.Karpov, A.S.Medvedko, E.I.Shubin*,- Precise Magnetometers on Base of Pulsed NMR Technologies. – XX-th Russian Conference on Charged Particle Accelerators RUPAC-2006, <http://rupac2006.inp.nsk.su/>.
- [5] *F.Briquez, O.Chubar, A.Dael, et al.*, GBI: Magnetic measurement bench triggered by interferometer, IMM-14, 26-29 September, Geneva, Switzerland, <http://immw2005.web.cern.ch/immw2005>
- [6] *Switching Handbook*. Third Edition. Keithley Instruments, Inc. p.2-11.
- [7] *I.Churkin, A.Batrakov, O.Chubar, et al.*, Elliptical undulator HU256 for Synchrotron SOLEIL: magnetic design, computation and measurements, *IEEE Transactions on Applied Superconductivity*, **Vol.16**, Issue 2, June 2006, p.1852.

- [8] *A.Batrakov, A.Dubrovin, I.Ilyin, et al.*, Prototype of Permanent Magnet Wiggler for the accelerator PETRA-III, Digest Reports of the XVI International Synchrotron Radiation Conference, July 10-14, 2006, Novosibirsk, Russia.
- [9] *В.Р.Козак*, - Многоканальный прецизионный аналого-цифровой преобразователь в стандарте VME. Препринт ИЯФ 2004-69, Новосибирск, 2004.

*A.Batrakov, I.Ilyin, V.Kozak, E.Kuper, V.Mamkin, V.Ovchar,
G.Fatkin, V.Tsukanov, P.Vobly, A.Volkov, S.Zverev*

**The New VME-based system for magnetic measurements
with Hall sensors**

*А. Батраков, И.Ильин, В.Козак, Э.Купер, В.Мамкин, В.Овчар,
Г. Фаткин, В.Цуканов, П. Воблый, А.Волков, С.Зверев*

**Новая VME-система для магнитных измерений
с помощью датчиков Холла**

ИЯФ 2007-32

Ответственный за выпуск А.М. Кудрявцев

Работа поступила 12.11. 2007 г.

Сдано в набор 12.11. 2007 г.

Подписано в печать 13.11. 2007 г.

Формат 60x90 1/16 Объем 1.0 печ.л., 0.8 уч.-изд.л.

Тираж 105 экз. Бесплатно. Заказ № 32

Обработано на РС и отпечатано

на ротапринте «ИЯФ им. Г.И. Будкера» СО РАН,
Новосибирск, 630090, пр. Академика Лаврентьева, 11